

Orion® StarBlast™ 4.5

4.5" Astro Reflector Telescope

#10015

Français

1 Pour obtenir le manuel d'utilisation complet, veuillez vous rendre sur le site Web **OrionTelescopes.eu/fr** et saisir la référence du produit dans la barre de recherche.

Mon compte · Suivi de commande · Chat · Aide | Français EUR
 Connexion
 Entrez le mot clé ou le numéro du produit Recherche

2 Cliquez ensuite sur le lien du manuel d'utilisation du produit sur la page de description du produit.

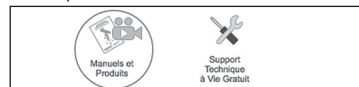

Deutsche

1 Wenn Sie das vollständige Handbuch einsehen möchten, wechseln Sie zu **OrionTelescopes.de**, und geben Sie in der Suchleiste die Artikelnummer der Orion-Kamera ein.

Mein Konto · Bestellstatus · Chat · Hilfe | Deutsch EUR
 Anmelden
 Geben Sie das Stichwort oder die Produktnummer ein Suchen

2 Klicken Sie anschließend auf der Seite mit den Produktdetails auf den Link des entsprechenden Produkthandbuchs.



Español

1 Para ver el manual completo, visite **OrionTelescopes.eu** y escriba el número de artículo del producto en la barra de búsqueda.

My Account · Order Status · Chat · Help | English EUR
 Sign In
 Enter keyword or product number Search

2 A continuación, haga clic en el enlace al manual del producto de la página de detalle del producto.



Italiano

1 Per accedere al manuale completo, visitare il sito Web **OrionTelescopes.eu**. Immettere the product item number nella barra di ricerca

My Account · Order Status · Chat · Help | English EUR
 Sign In
 Enter keyword or product number Search

2 Fare quindi clic sul collegamento al manuale del prodotto nella pagina delle informazioni sul prodotto.



Corporate Offices: 89 Hangar Way, Watsonville CA 95076 - USA
 Toll Free USA & Canada: (800) 447-1001
 International: +1(831) 763-7000
 Customer Support: support@telescope.com

Copyright © 2022 Orion Telescopes & Binoculars. All Rights Reserved. No part of this product instruction or any of its contents may be reproduced, copied, modified or adapted, without the prior written consent of Orion Telescopes & Binoculars.

Congratulations on your purchase of an Orion StarBlast 4.5 Astro Reflector telescope. If you have never owned a telescope before, we would like to welcome you to amateur astronomy. Take some time to familiarize yourself with the night sky. Learn to recognize the patterns of stars in the major constellations. With a little practice, a little patience, and a reasonably dark sky away from city lights, you'll find your telescope to be a never-ending source of wonder, exploration, and relaxation.

With its high-quality parabolic reflector optics and precision-engineered mechanics, the StarBlast 4.5 is not a toy, but rather an immensely capable astronomical instrument. Your telescope will arrive almost fully assembled out of the box! Only the visual accessories need to be installed. These include the EZ Finder II reflex sight and the eyepiece.

WARNING: Do NOT look at the Sun without a professionally made solar filter on the telescope; serious eye damage may result if you look at the Sun with any unfiltered optical instrument. Do not leave the telescope unsupervised around children. Always cover the lenses when leaving the telescope in direct sunlight.

This compact telescope is designed for grab-and-go portability. Whether you set it on a picnic table, the hood of your car, or on the ground, we're sure you and your family and friends will love scanning the night sky for its many hidden treasures.

The following instructions will help you to get the maximum performance from your new telescope, please read them thoroughly.

I. Parts List

- Optical tube
- Base
- 20mm Bertele eyepiece, 1.25"
- 10mm Bertele eyepiece, 1.25"
- EZ Finder II reflex sight
- Moon filter, 1.25"
- MoonMap 260
- Dust cap
- Allen wrench, 2mm

When unpacking the telescope it is suggested that you save the internal packaging. In the unlikely event the product needs to be returned, the shipping materials can be reused to ensure it arrives safely at its destination. Make sure all the parts listed in the Parts List and shown in **Figure 1** are present.

II. Anatomy of a Great Telescope.

Refer to **Figure 2** for this section.

1. Optical Tube – This is the part of the StarBlast that contains the mirror optics, which collect the distant starlight and direct it to the eyepiece for magnifying, focusing and viewing. Mirrors.

2. Tube Clamp – Holds the optical tube and connects it to the side panel of the base. The tube clamp knob at the top of the clamp can be loosened to allow you to rotate the tube to a comfortable eyepiece position.

3. Rack-and-Pinion Focuser – The focuser holds the eyepiece and has two focusing knobs that rotate in unison. You turn the focus knobs to achieve the sharpest possible image.

4. EZ Finder II Reflex Sight – A non-magnifying finder scope that helps you aim the telescope and locate objects in the sky for viewing. It emits a red LED "dot" that shows where your telescope is pointed.

5. 10mm Bertele Eyepiece – This eyepiece has a 10mm focal length, which produces 45x magnifying power with this telescope. The Bertele design comprises four lens elements, which are antireflection multi-coated. The barrel is threaded to accept Orion 1.25" filters.

6. Front Cell – This telescope's front cell holds the small secondary mirror, which directs the light reflected from the primary mirror out the side of the optical tube to the focuser and eyepiece for convenient viewing.

7. Altitude Tension Knob – This knob couples the tube clamp to the base's side panel and allows the tension between the two to be adjusted to allow smooth up/down movement of the optical tube that is neither too stiff nor too loose.

8. Base – The StarBlast 4.5's compact but sturdy base provides a stable mounting for the telescope. It glides smoothly in both the altitude (up/down) and azimuth (left/right) axes, making it easy to manually maneuver the telescope.

9. 20mm Bertele Eyepiece – This eyepiece has a 20mm focal length, which produces 22.5x magnifying power with this telescope. The Bertele design comprises four lens elements, which are antireflection multi-coated. The barrel is threaded to accept Orion 1.25" filters.

10. Eyepiece Rack – This handy rack has three holes to hold extra 1.25" eyepieces and accessories when they are not being used. It comes pre-installed on the base.

11. Feet – The three feet under the base provide support and have rubber pads on the bottom that grip smooth surfaces.

12. Carry Handle – A cutout in the side panel makes a convenient carrying handle for transporting the StarBlast 4.5 to your viewing site.

13. Rear Cell – The telescope's rear cell holds the parabolic primary mirror and features three collimation knobs that allow adjustment of the mirror's tilt. The collimation procedure – the method for making sure the optics are precisely aligned to yield the sharpest images is covered later in this manual.



Figure 2. Anatomy of a great telescope – the StarBlast 4.5.

III. Setting Up the Telescope

Your new TableTop telescope arrives with the optical tube already attached to the base. Carefully remove the assembled telescope from the shipping box and set it upright on its base. Remove the plastic bag from the telescope.

The telescope is packed with the optical tube oriented vertically in the base, with a foam pad between the optical tube and the base (**Figure 3A**). To rotate the tube into a “normal” position, you may have to first loosen the tube ring clamp knob, then pull the tube upward (**Figure 3B**). Then it should be possible to remove the foam block and rotate the tube. Be sure to retighten the clamp knob.

Install the EZ Finder II

Slide the foot of the EZ Finder’s bracket into the dovetail shoe on the telescope tube (**Figure 4**). Make sure the EZ finder II is oriented with the sight tube facing the front end of the telescope, as shown.

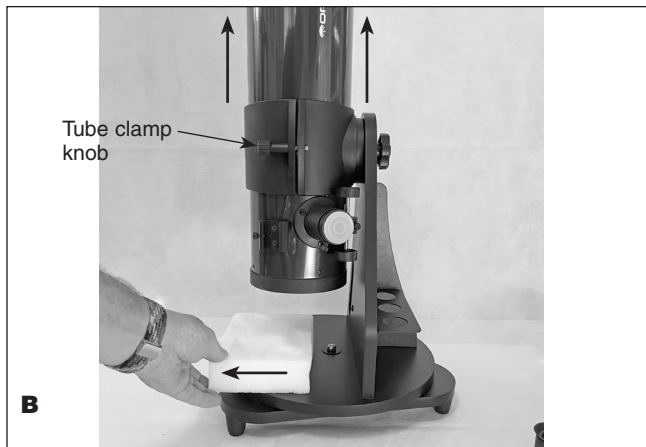

Figure 3. A) The telescope comes with a foam block between the optical tube and the base. **B)** To remove the block, loosen the tube clamp knob a turn or two, then slide the tube upward. Then remove the foam block.

Install and Eyepiece

The StarBlast 4.5 comes with two 4-element Bertele eyepieces: one of 20mm focal length and the other of 10mm focal length. More information about the eyepieces are provided later in this manual.

Insert an eyepiece directly into the focuser (**Figure 5**). First remove the cap from the focuser and loosen the two thumbscrews to provide clearance for the eyepiece barrel. Then insert the barrel of the eyepiece into the focuser and lightly retighten the thumbscrews.

Using the EZ Finder II Reflex Sight

The included EZ Finder II reflex sight (**Figure 6**) makes pointing your telescope almost as easy as pointing your finger. It permits easy object targeting prior to observation in the higher-power main telescope. It superimposes a red dot generated by an internal LED light on the sky, showing right where your telescope is pointed (**Figure 7**).

Before you can use the red dot finder scope, you must remove the small tab sticking out from the battery compartment. Doing so will allow the pre-installed 3V CR-2032 button cell battery to make contact with the EZ Finder II’s electronic circuitry to power its red LED illuminator. The tab can then be discarded.

Turn the power knob clockwise until you hear the “click” indicating that power has been turned on. Look through the back of the reflex sight with both eyes open to see the red dot inside the sight tube. Position your eye at a comfortable distance from the back of the unit. The brightness of the dot is adjusted by turning the power knob. For best results when stargazing, use the dimmest possible setting that allows you to see the dot without difficulty. Typically a dimmer setting is used under dark skies and a bright setting is used under light-polluted skies or in daylight.

Aligning the EZ Finder II

To use the red dot finder scope properly, it must be aligned with the main telescope. When the EZ Finder II is properly aligned with the telescope, an object that is centered on reflex sight’s red dot should also appear in the center of the field of view of the telescope’s eyepiece. Alignment is easiest to do during daylight hours, before observing at night. Follow this procedure:

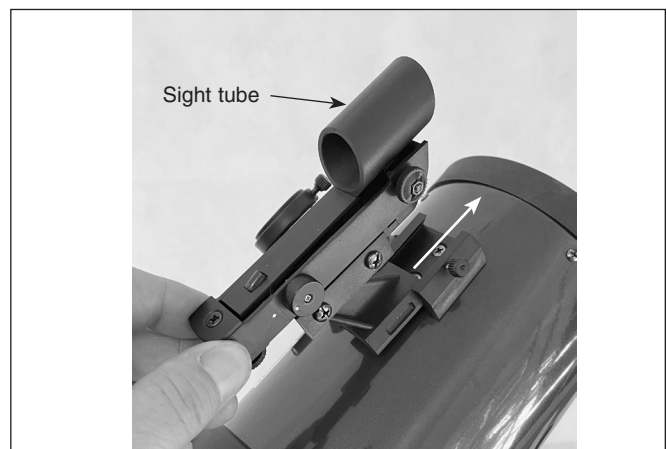

Figure 4. Slide the foot of the EZ Finder II bracket into the dovetail shoe on the telescope tube, as shown. Then tighten the thumbscrew.

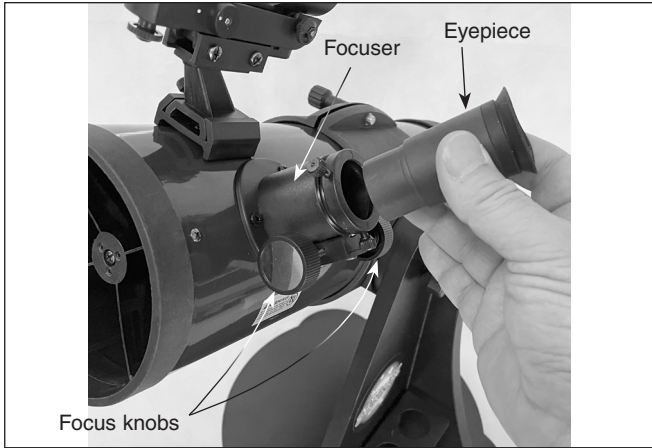

Figure 5. Insert an eyepiece into the focuser and secure it by lightly tightening the two thumbscrews.

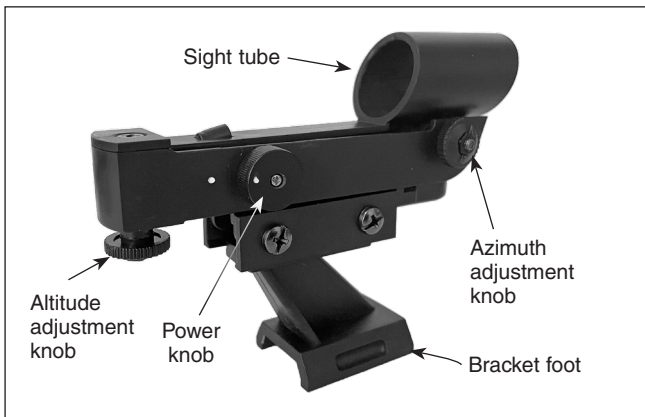

Figure 6. The EZ Finder II “red dot” scope

1. First, remove the dust cover from the front of the telescope.
2. With the 20mm eyepiece installed in the focuser, point the telescope at a well-defined land target (e.g., the top of a telephone pole) that’s at least a quarter mile away.
3. Center the target in the telescope eyepiece.
4. Next, you will also center the target object on the EZ Finder II’s red dot. Without moving the telescope, use the EZ Finder II’s altitude and azimuth adjustment knobs (shown in **Figure 6**) to position the red dot on the object.
5. When the red dot is centered on the distant object, check to make sure the object is still centered in the telescope’s eyepiece. If it isn’t, re-center it then adjust the EZ Finder II’s alignment again. When the object is centered in the telescope eyepiece and in the EZ Finder II, the EZ Finder II is properly aligned with the telescope.

The EZ Finder II’s alignment should be checked before each observing session. At the end of your observing session, be sure to turn the power knob counterclockwise until it clicks off.

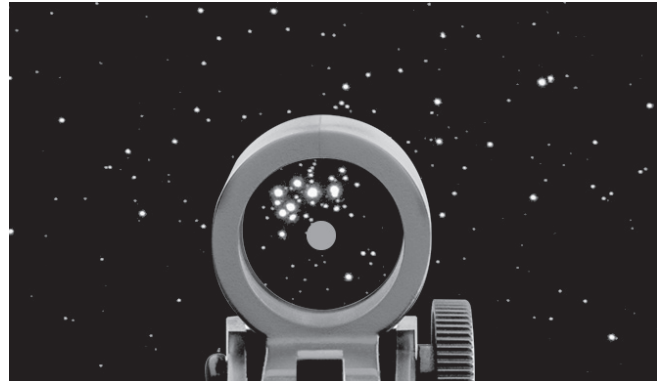

Figure 7. The EZ Finder II superimposes a tiny red dot on the sky, showing right where the telescope is pointed.

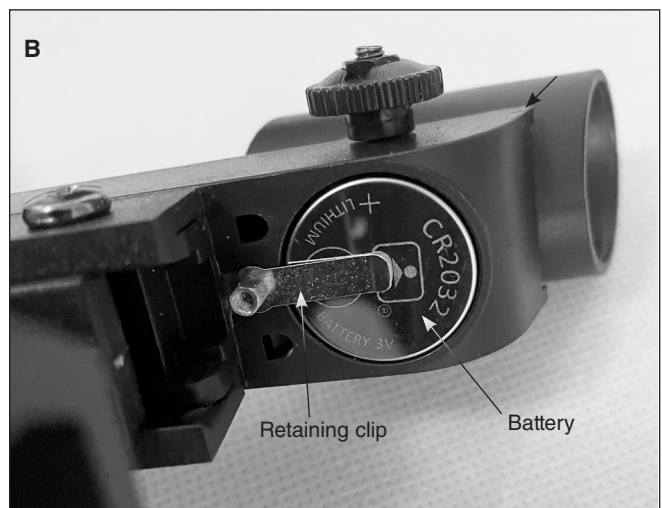
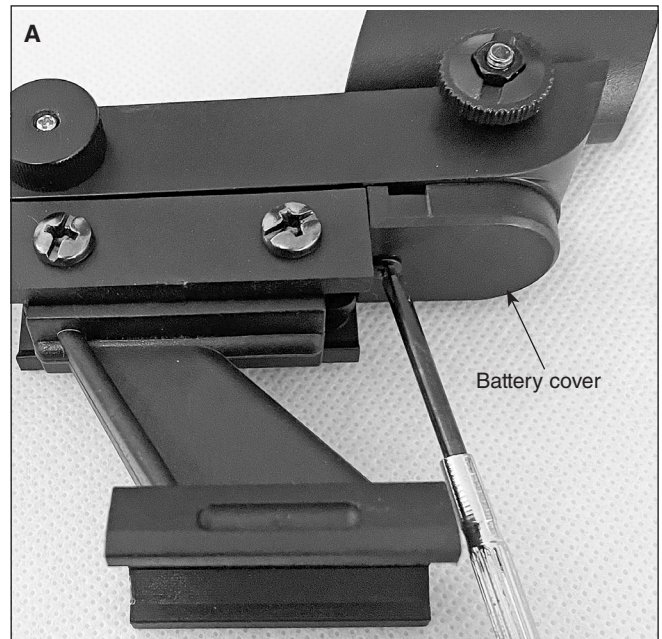

Figure 8. A) To replace the EZ Finder II’s CR2032 3V lithium battery, first remove the small Phillips screw to unlock the battery cover, **B)** then remove the old battery and replace it with the positive (+) side facing the retaining clip.

Replacing the Battery

Replacement 3-volt lithium (CR-2032) batteries are available from many retail outlets. To replace the dead battery, use a small Phillips head screwdriver to remove the battery cover (Figure 8A). Then carefully pull back on the retaining clip and shake out the old battery. Do not over-bend the retaining clip. Then slide the new battery under the retaining clip with the positive (+) side facing the clip as shown (Figure 8B).

III. Operating the Telescope

Eyeiece Selection

By using eyepieces of different focal lengths, it is possible to attain different magnifications with your telescope. That's because the magnifying power of a telescope is dependent on both the focal length of the telescope and of the eyepiece being used with it.

To calculate the magnification of a telescope-eyepiece combination, simply divide the focal length of the telescope by the focal length of the eyepiece.

$$\text{Magnification} = \frac{\text{Focal Length of Telescope (mm)}}{\text{Focal Length of Eyepiece (mm)}}$$

So, for example, the StarBlast 4.5 has a focal length of 450mm. When used with the 20mm eyepiece, the resulting magnification is 22.5x.

$$\frac{450\text{mm}}{20\text{mm}} = 22.5\text{x}$$

When using the 10mm eyepiece, the magnification is 45x.

$$\frac{450\text{mm}}{10\text{mm}} = 45\text{x}$$

The 20mm eyepiece is great for low power, wide field viewing, while the 10mm eyepiece is suited for higher-power observation. Other eyepieces can be used to achieve even higher powers. It is quite common for an observer to own five or more eyepieces to access a wide range of magnifications. An optional 2x Barlow lens is another great accessory to have. It doubles the magnifying power of any eyepiece it is used with.

We recommend starting a viewing session by inserting your lowest-power (longest focal length) eyepiece to locate and center the target object. Low magnification yields a wide field of view, which shows a larger area of sky in the eyepiece. This makes finding and centering an object much easier. Trying to find and center objects with a high power (narrow field of view) eyepiece is like trying to find a needle in a haystack! Once you've centered the object in the eyepiece, you can switch to a higher magnification (shorter focal length) eyepiece, if you wish. This is recommended for small and bright objects, like planets and double stars. The Moon also takes higher magnifications well. The best rule of thumb with eyepiece selection is to start with a low power, wide-field eyepiece, and then work your way up in magnification. If the object looks better, try an

even higher magnification eyepiece. If the object looks worse, then back off the magnification a little by using a lower-power eyepiece.

Magnification Limits

Every telescope has a useful magnification limit of about 2x per millimeter of aperture. This translates to a limit of 228x for the StarBlast 4.5 (4.5" equates to 114mm aperture). Some telescope manufacturers will use misleading claims of ultra-high magnifications: "See distant galaxies at 640X!" While such magnifications are technically possible, the actual image at that magnification would be a dim, indistinct blur. Low and moderate magnifications are what give the best views. A small, but bright and crisply detailed image is always better than a dim, blurry, over-magnified one.

Image Orientation

The image in the eyepiece will appear rotated (upside down) in the StarBlast 4.5. This is normal for reflector telescopes. But this is also why reflector telescopes are not recommended for daytime terrestrial use. For astronomical viewing the orientation of the image matters little, as there is no "right side up" in space!

On or Off the Ground? Your Choice

One of the great qualities of the StarBlast 4.5 Astro Reflector is its conveniently compact, portable size. The cutout in the side panel makes a perfect carrying handle for taking the StarBlast wherever you want to go. You may find that the most comfortable way to use the telescope is while sitting down or kneeling on the ground next to it. If you wish to raise the telescope off the ground a bit so that it can be used while standing or sitting in a chair, then setting it on a platform such as a milk crate, a camping table, or a picnic table might be just the ticket.

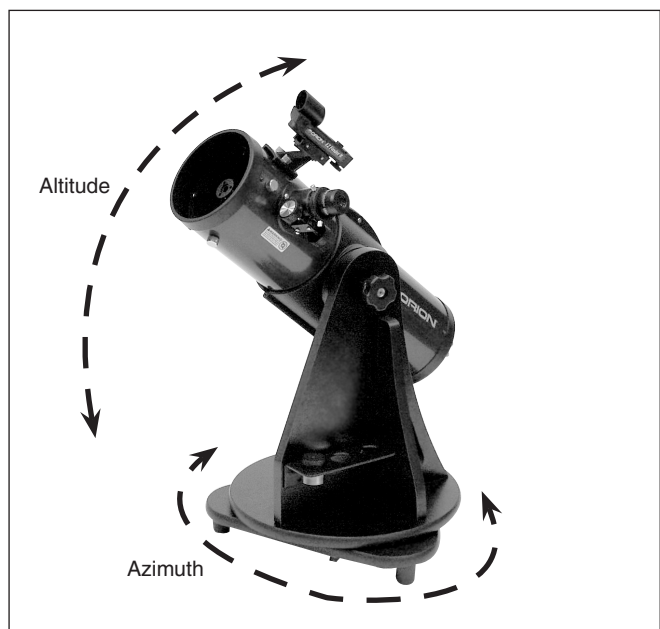

Figure 9. The StarBlast has two axes of motion: altitude (up/down) and azimuth (left/right).

Altitude and Azimuth (Aiming the Telescope)

Your StarBlast 4.5 telescope's base permits motion along two axes: altitude (up/down) and azimuth (left/right) (**Figure 9**). Both motions can be made simultaneously and in a continuous manner for easy aiming. This way you can point to any position in the night sky, from horizon to horizon.

The altitude axis rotation tension is adjustable with the altitude tension adjustment knob (**Figure 2**). You want sufficient friction of motion to keep the telescope from rotating too freely, which can make it difficult to land on and stay aimed at an object you wish to view. However, if you apply too much tension the telescope will be difficult to move smoothly and in small increments needed to center an object in the eyepiece for viewing. Turn the tension adjustment knob to set the right amount of friction.

The rotation tension of the azimuth axis is set at the factory and should allow smooth, easy rotation of the base to the left or right.

Focusing the Telescope

The StarBlast 4.5 comes equipped with a 1.25" rack-and-pinion focuser (**Figure 5**). We recommend practicing focusing in the daytime when starting out to get the hang of it. With the 20mm eyepiece inserted into the focuser, aim the optical tube so the front (open) end is pointing in the general direction of an object at least 1/4-mile away. With your fingers, slowly rotate either of the two the focus knobs (they rotate in unison) until the object comes into sharp focus. Go a little bit beyond sharp focus until the image starts to blur again, then reverse the rotation of the knob gradually, until you've nailed the exact focus point.

You can adjust the position of the focuser to the angle that is most comfortable for viewing by simply loosening the tube clamp knob, then rotating the optical tube until the focuser is where you want it.

IV. Using Your Telescope

Choosing an Observing Site

When selecting a location for observing, get as far away as possible from direct artificial light such as street lights, porch lights, and automobile headlights. The glare from these lights will greatly impair your dark-adapted night vision. Avoid viewing over rooftops and chimneys, as they often have warm air currents rising from them. Similarly, avoid observing from indoors through an open (or closed) window, because the temperature difference between the indoor and outdoor air will cause image blurring and distortion.

If at all possible, escape the light-polluted city sky and head for darker country skies. You'll be amazed at how many more stars and deep-sky objects are visible in a dark sky!

Cooling the Telescope

All optical instruments need time to reach "thermal equilibrium." The bigger the instrument and the larger the temperature change, the more time is needed. Allow at least 20 minutes for your telescope to acclimate to the temperature outdoors before you start observing with it.

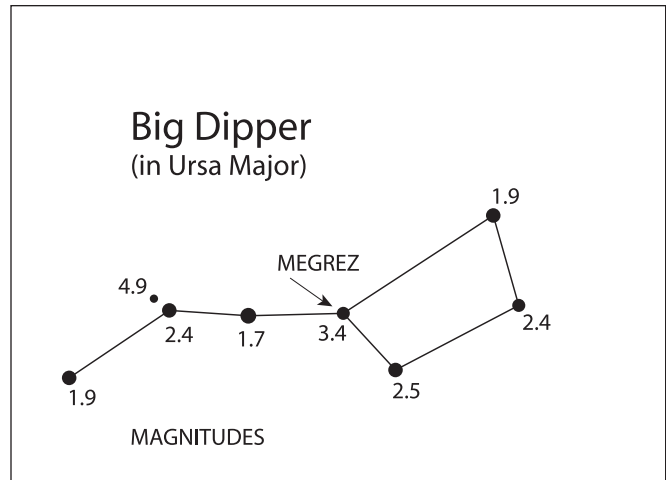

Figure 10. Megrez connects the Big Dipper's "handle" to its "pan." If you cannot see Megrez, a magnitude 3.4 star, then the viewing conditions are poor.

Let Your Eyes Dark-Adapt

Don't expect to go from a lighted house into the darkness of the outdoors at night and immediately see faint nebulas, galaxies, and star clusters—or even very many stars, for that matter. Your eyes take about 30 minutes to reach perhaps 80% of their full dark-adapted sensitivity. As your eyes become dark-adapted, more stars will glimmer into view and you'll be able to see fainter details in objects you view in your telescope.

To see what you're doing in the darkness, use a red-filtered flashlight rather than a white light. Red light does not spoil your eyes' dark adaptation like white light does. A flashlight with a red LED light is ideal. Beware, too, that nearby porch lights, street lights, and car headlights will ruin your night vision.

"Seeing" and Transparency

Atmospheric conditions vary significantly from night to night. "Seeing" refers to the steadiness of the Earth's atmosphere at a given time. In conditions of poor seeing, atmospheric turbulence causes objects viewed through the telescope to "boil." If you look up at the sky and stars are twinkling noticeably, the seeing is poor and you will be limited to viewing at lower magnifications. At higher magnifications, images will not focus clearly. Fine details on the planets and Moon will likely not be visible.

In conditions of good seeing, star twinkling is minimal and images appear steady in the eyepiece. Seeing is best overhead, worst at the horizon. Also, seeing generally gets better after midnight, when much of the heat absorbed by the Earth during the day has radiated off into space.

Especially important for observing faint objects is good "transparency" – air free of moisture, smoke, and dust. All tend to scatter light, which reduces an object's brightness. Transparency is judged by the magnitude of the faintest stars you can see with the unaided eye (6th magnitude or fainter is desirable). If you cannot see stars of magnitude 3.5 or dimmer then conditions are poor. Magnitude is a measure of how bright a star is – the brighter a star is, the lower its magnitude will be. A good star to remember for this is Megrez (mag. 3.4), which is the star in the

“Big Dipper” connecting the handle to the “dipper.” If you cannot see Megrez, then you have fog, haze, clouds, smog, or other conditions that are hindering your viewing. (See **Figure 10**.)

Tracking Celestial Objects

The Earth is constantly rotating about its polar axis, completing one full rotation every 24 hours; this is what defines a “day.” We do not feel the Earth rotating, but we see it at night from the apparent movement of stars from east to west. When you observe any astronomical object, you are watching a moving target. This means the telescope’s position must be continuously adjusted over time to keep a celestial object in the field of view. This is called “tracking” the object. It’s easy to do with the StarBlast 4.5 because of its smooth motions on both axes. As the object moves off toward the edge of the eyepiece’s field of view, just lightly nudge or tug the telescope to re-center the object. Objects appear to move across the field of view faster at higher magnifications. This is because the field of view becomes narrower.

Using the Orion Moon Filter and MoonMap 260

Orion Moon Filter

This popular accessory reduces glare from the bright lunar surface for more comfortable viewing. It also boosts contrast so you can enjoy more-detailed views of surface features. The neutral density filter transmits only 13% of incoming light to the eyepiece, preventing the overpowering brightness from washing out details, providing better clarity and resolution, and reducing eye strain. It does not alter the natural color of the Moon, either. Just screw the filter into the threaded barrel of the eyepiece and you’re all set (**Figure 11**).

Orion MoonMap 260

With locations and names of over 260 features on the Moon such as craters, mountains, valleys, “seas” and more, the Orion MoonMap 260 is a great tool for beginning astronomers. This detailed map will even show you where various spacecraft have landed on the Moon’s surface! The whole family will enjoy looking at the Moon with the telescope, then using the MoonMap 260 to learn the names of the craters and other features observed. Using a red flashlight (sold separately) to read the MoonMap in the dark will be helpful; the red light will not spoil your eyes’ dark adaptation.

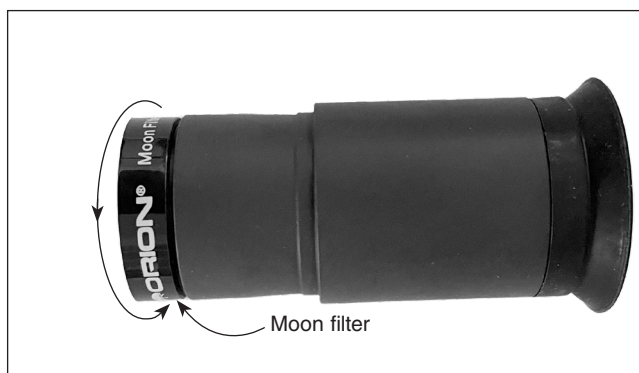

Figure 11. The Moon filter threads into the eyepiece barrel as shown.

What to Expect

So what will you see with your telescope? You should be able to see bands on Jupiter, the rings of Saturn, craters on the Moon, the waxing and waning of Venus, and many bright deep-sky objects. Do not expect to see color as you do in Hubble Space Telescope photos, since those are taken with long-exposure cameras and have “false color” added. Our eyes are not sensitive enough to see color in deep-sky objects. But remember that you are seeing these objects using your own telescope with your own eyes, in real time. And that’s pretty cool!

V. Objects to Observe

Now that you are all set up and ready to go, one critical decision must be made: what to look at?

A. The Moon

With its rocky surface, the Moon is one of the easiest and most interesting targets to view with your telescope. Lunar craters, maria, and even mountain ranges can all be clearly seen from a distance of 238,000 miles away! With its ever-changing phases, you’ll get a new view of the Moon every night. The best time to observe our one and only natural satellite is during a partial phase, that is, when the Moon is NOT full. During partial phases, shadows are cast on the surface, which reveal more detail, especially right along the border between the dark and light portions of the disk (called the “terminator”). A full Moon is too bright and devoid of surface shadows to yield a pleasing view. Make sure to observe the Moon when it is well above the horizon to get the sharpest images. Use the included Moon Filter to dim the Moon when it is very bright. It simply threads onto the bottom of the eyepiece barrel. You’ll find that a Moon filter improves viewing comfort, and also helps to bring out subtle features on the lunar surface.

B. The Sun

You can change your nighttime telescope into a daytime Sun viewer by installing an optional full-aperture solar filter over the front opening of the telescope. The primary attraction is sunspots, which change shape, appearance, and location daily. Sunspots are directly related to magnetic activity in the Sun. Many observers like to make drawings of sunspots to monitor how the Sun is changing from day to day.

Important Note: Do not look at the Sun with this telescope without a professionally made solar filter installed on the front opening, or permanent eye damage or blindness could result! Do not use the EZ Finder II when solar viewing, either.

C. The Planets

Planets, being in our own solar system and having their own orbits, do not stay at “fixed” locations like the stars do. So to find them you should refer to Sky Calendar at our website (telescope.com), or to charts published monthly in Astronomy or Sky & Telescope magazines, or on astronomy websites. Venus, Jupiter, and Saturn are the brightest objects in the sky after the Sun and the Moon. Other planets may be visible but will likely appear star-like. Because planets are quite small in apparent size, you will need to use high power. Not all the planets are generally visible at any one time.

JUPITER: The largest planet, Jupiter, is a great subject for observation. You can see the disk of the giant planet and watch the ever-changing positions of its four largest moons -- Io, Callisto, Europa, and Ganymede.

SATURN: The ringed planet is a breathtaking sight when it is well positioned. The tilt angle of the rings varies over a period of many years; sometimes they are seen edge-on, while at other times they are broadside and look like giant “ears” on each side of Saturn’s disk. A steady atmosphere (good seeing) is necessary for a good view. You will probably see a bright “star” close by, which is Saturn’s brightest moon, Titan.

VENUS: At its brightest, Venus is the most luminous object in the sky, excluding the Sun and the Moon. It is so bright that sometimes it is visible to the naked eye during full daylight! Ironically, Venus appears as a thin crescent, not a full disk, when at its peak brightness. Because it is so close to the Sun, it never wanders too far from the morning or evening horizon. No surface markings can be seen on Venus, which is always shrouded in dense clouds.

D. The Stars

Stars will appear like twinkling points of light. Even powerful telescopes cannot magnify stars to appear as more than a point of light. You can, however, enjoy the different colors of the stars and locate many pretty double and multiple stars. The gorgeous two-color double star Albireo in Cygnus is a favorite. Defocusing a star slightly can help to bring out its color.

E. Deep-Sky Objects

Under dark skies, you can observe a wealth of fascinating deep-sky objects, including gaseous nebulas, open and globular star clusters, and a variety of different types of galaxies. Most deep-sky objects are very faint, so it is important that you find an observing site well away from light pollution. Take plenty of time to let your eyes adjust to the darkness. Do not expect these subjects to appear like the photographs you see in books and on the internet; most will look like dim gray smudges. Our eyes are not sensitive enough to see color in deep-sky objects. But as you become more experienced and your observing skills get sharper, you will be able to ferret out more and more subtle details and structure.

To find deep sky objects in the sky, it is best to consult a star chart, planetarium program or app, or a planisphere. These guides will help you locate the brightest and best deep-sky objects for viewing with your telescope. You can also try low-power scanning of the Milky Way. Pop in the 20mm eyepiece and just cruise through the “star clouds” of our galaxy. You’ll be amazed at the rich fields of stars and objects you’ll see! The Milky Way is best observed on summer and winter evenings.

VI. Care and Maintenance

If you give your telescope reasonable care, it will last a lifetime. Store it in a clean, dry, dust-free place, safe from rapid changes in temperature and humidity. Do not store the telescope outdoors, although storage in a garage or shed is okay. Small components like eyepieces and other accessories should be kept in a protective box or storage case. Keep the dust cover on the front of the telescope when it is not in use.

VII. Specifications

Optical design	Newtonian reflector
Primary mirror figure	Parabolic
Primary mirror coating	Aluminum with SiO ₂ overcoat
Secondary mirror	34mm minor axis diameter
Secondary mirror coating	Aluminum with SiO ₂ overcoat
Aperture	114mm
Focal length	450mm
Focal ratio	f/3.9
Central obstruction diameter	34mm
Focuser	Rack and pinion, 1.25"
Base	MDF material with laminate finish
Mounting saddle	Vixen-style dovetail with clamp knob
Optical tube mounting adapter	Vixen-style dovetail bar; two ¼"-20 threaded holes on bottom
Eyepieces	20mm 4-element Bertele design, 1.25", multi-coated 10mm 4-element Bertele design, 1.25", multi-coated
Magnification with supplied eyepieces	22.5x (20mm) and 45x (10mm)
Finder scope	EZ finder II reflex sight (3V lithium ion battery included)
Moon filter	Neutral density, 13% transmission, 1.25"
Weight, assembled telescope	10lbs. 13.8 oz
Optical tube length	17.75"
Base diameter and height	14" D x 17" H

Appendix A

Collimation – Aligning the Optics

Collimation is the process of adjusting the optics of a telescope so they are precisely aligned with one another and with the telescope tube. For this reflector telescope, the primary and secondary mirrors must be in precise alignment. Your telescope's optics were aligned at the factory, and should not need



Figure 12. Before collimating your telescope, place a piece of white paper inside the optical tube opposite the focuser. Make sure the telescope tube is oriented parallel to the ground during the collimation process.

much adjustment unless the telescope is handled roughly. Accurate mirror alignment is important to ensure the sharpest possible images viewed through your telescope, so it should be checked occasionally. With practice, collimating is relatively easy to do and can be done in daylight.

It helps to perform the collimation procedure in a brightly lit room with the telescope pointed toward a bright surface, such as a light-colored wall. The telescope tube should be oriented horizontally (parallel to the ground). Placing a piece of white paper in the telescope tube opposite the focuser (i.e., on the other side of the secondary mirror from the focuser) will also be helpful (see **Figure 12**). You will need the included 2mm Allen wrench and a philips screwdriver to perform the collimation.

To check your telescope's collimation, remove the eyepiece and look down the focuser. You should see the secondary mirror centered in the focuser, as well as the reflection of the primary mirror centered in the secondary mirror, and the reflection of the secondary mirror (and your eye) centered in the reflection of the primary mirror, as in **Figure 13A**. Got all that? Review it again carefully, and compare what you see to **Figure 13A**. If anything is off-center, proceed with the following collimation procedure.

NOTE: Precise collimation is best achieved by using an optional collimating tool, such as a quick-collimation cap, a Cheshire eyepiece, or a laser collimator. Check our website for available collimating tools. Figures 13B through 13D assume that you have an optional Cheshire eyepiece or collimation cap in the focuser.

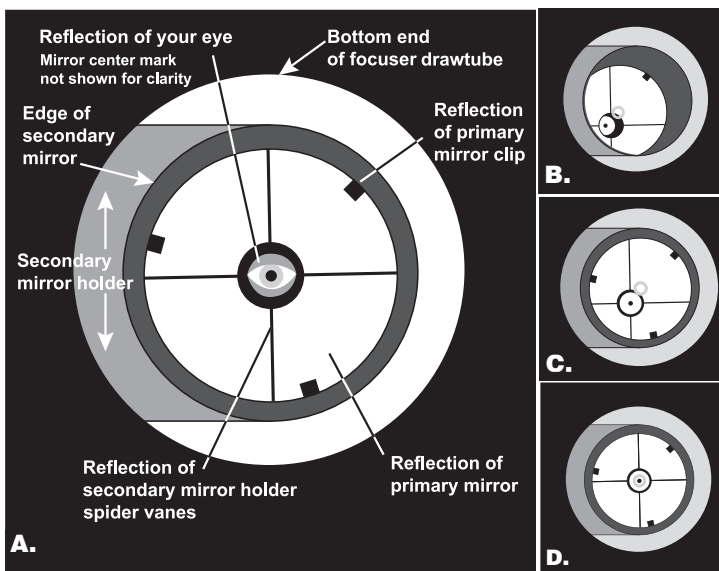

Figure 13. Collimating the optics. **(A)** When the mirrors are properly aligned, the view down the focuser drawtube should look like this. **(B)** Here, only part of the primary mirror is visible in the secondary mirror, so the secondary mirror needs to be adjusted (tilted). **(C)** Here the secondary mirror is correctly aligned because the entire primary mirror is visible in it. But the reflection of the secondary mirror is off-center. So the primary mirror still needs adjustment. **(D)** Now the primary mirror is correctly aligned, so the secondary mirror is centered.

Primary Mirror Center Mark

You may have noticed that your StarBlast 4.5 has a small adhesive ring in the exact center of the primary mirror. This “center mark” allows you to achieve a very precise collimation of the primary mirror; you don’t have to guess where the center of the mirror is, which is important in the collimation process. This center mark is especially useful when using an optional collimating device.

Note: *The adhesive ring should not be removed from the primary mirror. Because it lies directly in the shadow of the secondary mirror, its presence in no way adversely affects the optical performance of the telescope or the image quality. That might seem counter-intuitive, but it’s true! Leave it in place.*

Aligning the Secondary Mirror

Align the secondary mirror first. Note secondary mirror collimation screws are Allen screws, so you will need to use the included 2mm Allen wrench to adjust them.

Look down the focuser at the secondary (diagonal) mirror. If the entire primary mirror reflection is not visible in the secondary mirror, as in **Figure 13B**, you will need to adjust the tilt of the secondary mirror. This is done by alternately loosening one of the three secondary mirror alignment screws then lightly tightening the other two (**Figure 14**). The goal is to center the primary mirror reflection in the secondary mirror, as in **Figure 13C**. Don’t worry that the reflection of the secondary mirror (the smallest circle) is off-center. You will fix that in the next step. It will take some trial and error to determine which screws to loosen and tighten to move the reflection of the primary mirror to the center of the secondary mirror. But be patient and you’ll get it.

Aligning the Primary Mirror

The final adjustment is made to the primary mirror. It will need adjustment if, as in **Figure 13C**, the reflection of the primary mirror is centered in the secondary mirror, but the small reflection of the secondary mirror is off-center. The tilt of the primary mirror is adjusted using three spring-loaded collimation knobs and three smaller locking thumbscrews on the back end of the optical tube (**Figure 15**). First loosen the three locking thumbscrews a turn or so. Then tighten one of the collimation knobs about a quarter turn and see if the secondary mirror reflection has moved closer to the center of the primary. If it moved farther away then try loosening the same collimation knob a bit. Repeat this process on the other two sets of collimation screws, if necessary, adjusting them one way or the other and seeing if the secondary mirror reflection moves closer to the center of the primary mirror reflection. It will take a little trial and error to get a feel for how to tilt the mirror in this way. When the center hole in your collimating tool is centered as much as possible on the reflection of the adhesive dot on the primary mirror, your primary mirror is collimated. The view through the collimation cap should resemble **Figure 13D**. Finally, very lightly tighten the three locking thumbscrews so that the primary mirror stays in that position. A simple star test will tell you whether the optics are accurately collimated.



Figure 14. Use the included 2mm Allen wrench to adjust the three secondary mirror collimation setscrews.

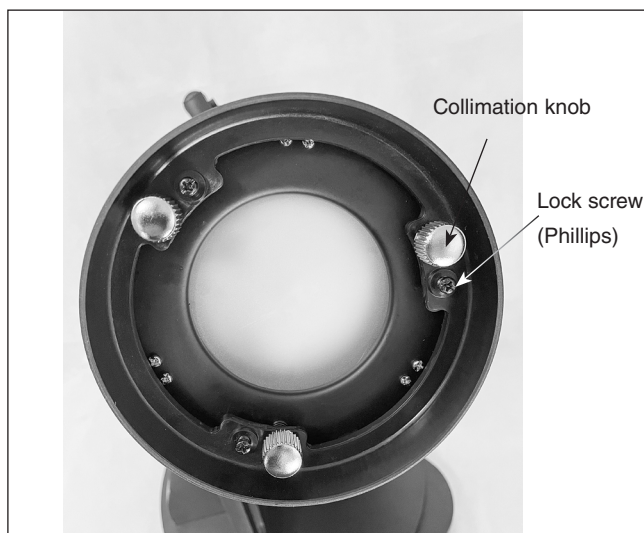

Figure 15. The optical tube’s rear cell has three pairs of collimation screws. The large knobs are the spring-loaded collimation knobs while the smaller Phillips screws are the locking screws.

Star-Testing the Telescope

When it is dark, point the telescope at a bright star and accurately center it in the eyepiece's field of view. Slowly de-focus the image with the focusing knob. If the telescope is correctly collimated, the expanding disk should be a perfect circle (**Figure 16**). If the image is unsymmetrical, the scope is out of collimation. The dark shadow cast by the secondary mirror should appear in the very center of the out-of-focus circle, like the hole in a donut. If the "hole" appears off-center, the telescope is out of collimation.

If you try the star test and the bright star you have selected is not accurately centered in the eyepiece, the optics will always appear out of collimation, even though they may be perfectly aligned. It is critical to keep the star centered, so over time you may need to make slight corrections to the telescope's position in order to keep the star in the center of the field of view. A good star to point at for a star test is Polaris, the North Star, because its position does not move significantly over time.

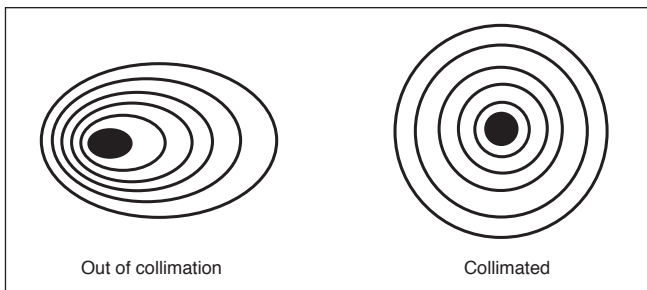

Figure 16. A star test will determine if the telescope's optics are properly collimated.

Appendix B

Cleaning the Optics

Cleaning Lenses

Any quality optical lens cleaning tissue and optical lens cleaning fluid specifically designed for multi-coated optics can be used to clean the exposed lenses of your eyepieces. Never use regular glass cleaner or cleaning fluid designed for eyeglasses. Before cleaning with fluid and tissue, blow any loose particles off the lens with a blower bulb. Then apply some cleaning fluid to a tissue, never directly on the optics. Wipe the lens gently in a circular motion, applying only very slight pressure, then remove any excess fluid with a fresh lens tissue. Oily fingerprints and smudges may be removed using this method. Use caution; rubbing too hard may scratch the lens. On larger lenses, clean only a small area at a time, using a fresh lens tissue on each area. Never reuse tissues.

Cleaning Mirrors

You should not have to clean the StarBlast 4.5's primary mirror very often, if ever. Covering the telescope with the dust caps on the front opening and on the focuser when not in use will help prevent dust from accumulating on the mirrors. When bringing the telescope inside after an evening's viewing it is normal for moisture to accumulate on the mirror due to the change in temperature. We suggest leaving it uncovered overnight to allow this condensation to evaporate. Improper cleaning can scratch mirror coatings, so the fewer times you have to clean the mirrors, the better. Small specks of dust or flecks of paint on the mirror have virtually no effect on the visual performance of the telescope.

If you believe your telescope primary mirror needs cleaning, please email us at: support@telescope.com or contact Orion Technical Support at (800) 676-1343.



One-Year Limited Warranty

This Orion product is warranted against defects in materials or workmanship for a period of one year from the date of purchase. This warranty is for the benefit of the original retail purchaser only. During this warranty period Orion Telescopes & Binoculars will repair or replace, at Orion's option, any warranted instrument that proves to be defective, provided it is returned postage paid. Proof of purchase (such as a copy of the original receipt) is required. This warranty is only valid in the country of purchase.

This warranty does not apply if, in Orion's judgment, the instrument has been abused, mishandled, or modified, nor does it apply to normal wear and tear. This warranty gives you specific legal rights. It is not intended to remove or restrict your other legal rights under applicable local consumer law; your state or national statutory consumer rights governing the sale of consumer goods remain fully applicable.

For further warranty information, please visit www.OrionTelescopes.com/warranty.



Corporate Offices: 89 Hangar Way, Watsonville CA 95076 - USA
Toll Free USA & Canada: (800) 447-1001
International: +1(831) 763-7000
Customer Support: support@telescope.com

Copyright © 2022 Orion Telescopes & Binoculars. All Rights Reserved. No part of this product instruction or any of its contents may be reproduced, copied, modified or adapted, without the prior written consent of Orion Telescopes & Binoculars.